

HD UTILITY

GRIP-LOCK™

PROLIFT™

# PROFILE™

INTRODUCING THE #1 NEW ROOF RACK SYSTEM OF 2022



# HAUL LIKE A PRO



**ADRIAN STEEL®**

Cargo Management Solutions for Commercial Vehicles



## **ENGINEERED AND MANUFACTURED IN MICHIGAN, BY AMERICANS.**

Our goal is to make work safer and more efficient for vehicle operators. We do this through customized upfitting that reduce inefficiencies and risk of injury with ergonomic products and solutions.

Built for hard workers, our products are specifically designed to stand the test of time, in all climates, to provide reliable functionality for the life of the vehicle. With less than 1% quality claims annually, we take pride in providing you the best U.S. made products on the market and back it by our 3-year/36,000 mile warranty.



# HAULLIK

# PROFILE™

## PROFILE™ BY DESIGN.

Ultra-low profile, aerodynamic construction is the ultimate lightweight & tough roof rack system. The clean, simple all-aluminum construction, stainless steel hardware and durable powder-coat finish is built to withstand heavy use and ensure years of dependability. Designed to adapt to almost any vehicle, the unique modular design can be easily upgraded for specific utility use. This is a superior rack system for all your needs.



# TAKE A PRO

# PROFILE™

Roof Rack Series

**BUILT FOR HARD WORK,  
DESIGNED FOR PROFESSIONALS.**

Sleek, Low Profile Design

Leading Safety and Security

Rugged, Durable Components

Industry-Leading Customization

ProLift™: The NEW Drop-Down  
Performance Leader

## **ONE BASE FOR ANY RACK.**

The base of the rack is made up of OEM specific mounting feet and powder coated aluminum crossbars with slide channels for easy accessory and add-on installation. These crossbars are the base for any rack option in the PROFILE™ Series.





# HD UTILITY

## HD UTILITY RACK

A versatile workhorse. Sleek and low-profile for great looking integration on any vehicle. Specifically designed to be clean, tough and versatile.



## GRIP-LOCK™ LADDER RACK

The 'Gorilla' of locking ladder systems. Rust-free, heavy duty aluminum construction with ultra-premium wear strips and long-lasting components.



## PROLIFT™ LADDER RACK

All-New drop-down ladder rack technology that delivers the Ultimate in Performance...Brilliantly Simple, Sturdy and Unmatched Ease-of-Use.

# PROLIFT

## SAFE & ERGONOMIC

### UP TO 50% LIGHTER OPERATION

The ProLift™ is up to 50% easier to operate than comparable drop-down style ladder racks. This makes it the easiest and safest drop-down ladder rack system on the market. Using unique patent pending mechanical advantages and high-performance spring assist struts, Pro-Lift™ raises and lowers ladders with an almost effortless pull, saving you time and energy while reducing back and shoulder injuries. Built on Adrian Steel's new flagship Profile™ rack system, the Pro-Lift™ is low profile, lightweight and built to last.

### Two Stage Drop-Down

### Single Stage Drop-Down

### INCREASED OPERATOR SAFETY

The low-force operation is extremely smooth to reduce operator fatigue and injuries so you can get the job done efficiently, effortlessly and safely.

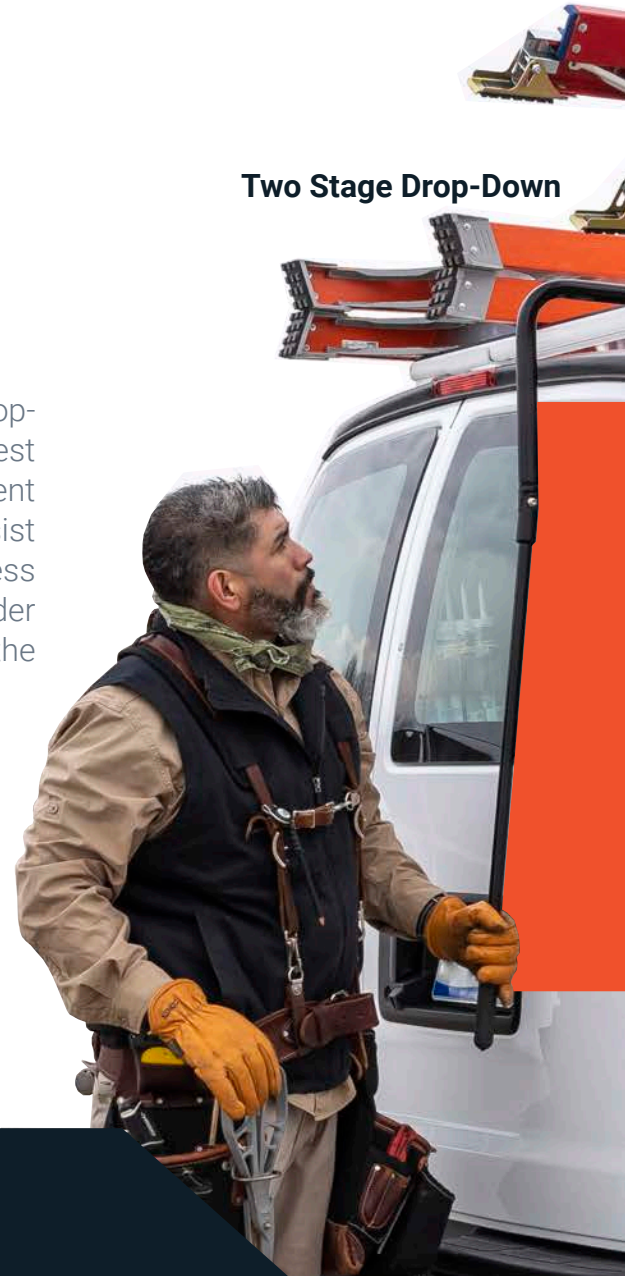
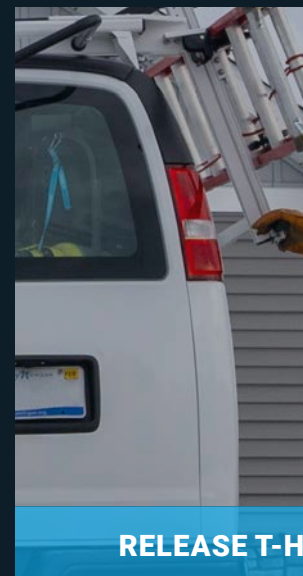
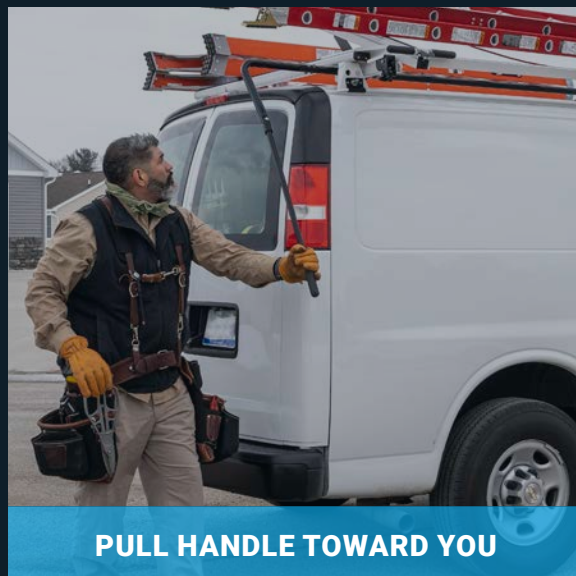
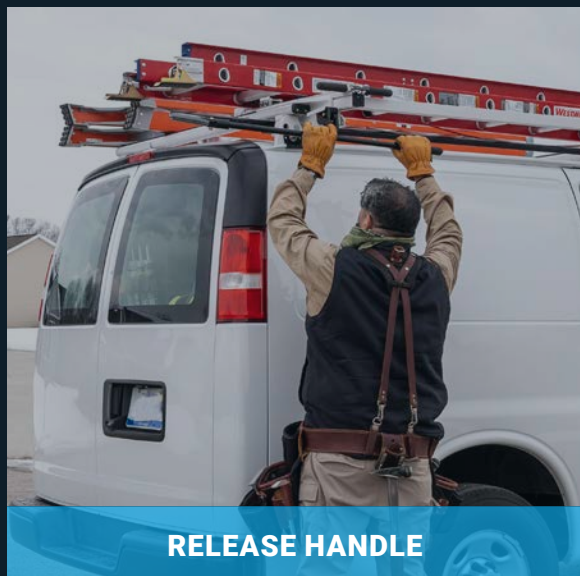



UP TO  
**50%**  
LESS ENERGY  
NEEDED TO OPERATE  
VS COMPARABLE  
DROP-DOWN STYLE  
RACKS

### PROLIFT™ OPTIONS:

#### Single Stage Drop-Down

- Designed with ladder hooks, this option lowers off of the van to a single set position.

#### Single Stage Drop-Down w/ Double Ladder Stack

- Same single stage action with taller hooks to accommodate two ladders.

#### Two Stage Drop-Down<sup>(shown)</sup>

- The two stage drops off of the van to a set height with a cartridge and handle that lowers the rear of the ladder closer to the ground. Designed for mid and high roof applications, but also works on low roof vehicles.



**HANDLE LATCH**

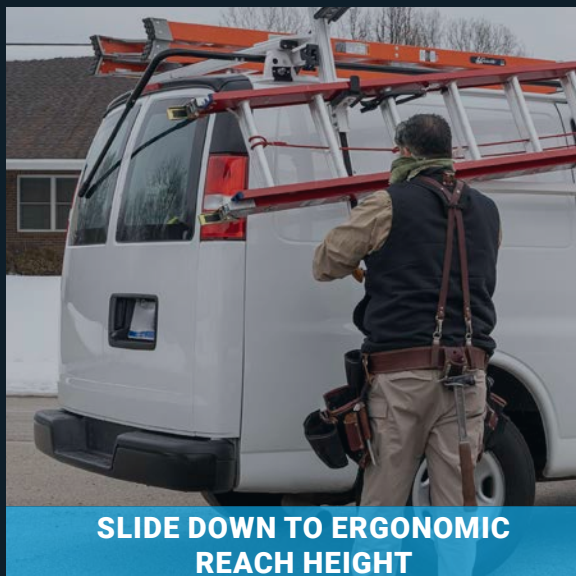

**SLIDE DOWN TO ERGONOMIC REACH HEIGHT**



**PLACE REAR OF LADDER ON THE GROUND AND REMOVE FROM RACK.**

# PROLIFT

## ULTIMATE VERSATILITY & CAPABILITY

This superior multi-use ladder rack offers secure, safe storage for extension ladders, step ladders and A-frame ladders.

Fits extension ladders up to 40 ft. and step/podium ladders up to 10 ft. with easy operation up to 100 lbs.

## CORROSION RESISTANT

All components are aluminum with a plastisol or powder-coat finish to withstand the elements and help prevent rust.

## LOCKABLE ATTACHED HANDLE

Prevents losing your ladder rack handle and wasting time obtaining a new one. Pad-Lock capable to prevent theft.

## PULL ASSIST GAS SPRINGS

Dampens the load during operation to prevent damage to the vehicle while also reducing operating force.

## RUGGED WEAR STRIPS

Protects and helps increase the life of your ladders.

## ADJUSTABLE CLAMP PADS

Get a snug fit on any ladder with just a half inch wrench or ratchet/socket.

## LADDER GUIDE / VAN GUARD

Help guide the ladder into the front bracket while also preventing damage to the van from the ladder.

## EASY RELEASE T-HANDLE

Press and release with thumb to activate the secondary slide.

## SECONDARY SLIDE

The secondary slide lowers the ladder to a lower more ergonomic reach height to prevent back and shoulder injuries during operation.

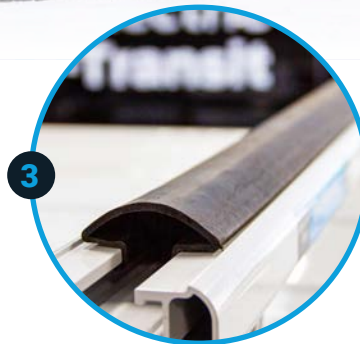

RUGGED WEAR STRIPS



PULL ASSIST GAS SPRINGS



LOCKABLE ATTACHED HANDLE  
*only available on low roof vehicles*



ADJUST WITH JUST A  
1/2" WRENCH OR RATCHET.





# BUILT FOR PROFESSIONALS



## STREAMLINED PROFESSIONAL APPEARANCE

The sleek, modern and integrated design was specifically engineered and tested to prevent wind drag and noise giving you full-features and full functionality without the weight and bulk. Plus, you'll prevent ugly rust streaks from a corroding rack, giving your business a clean appearance to your current and potential customers.



**ADJUSTABLE CLAMP PADS**



**LADDER GUIDE / VAN GUARD**



**SECONDARY SLIDE**  
*only available on the two stage option*

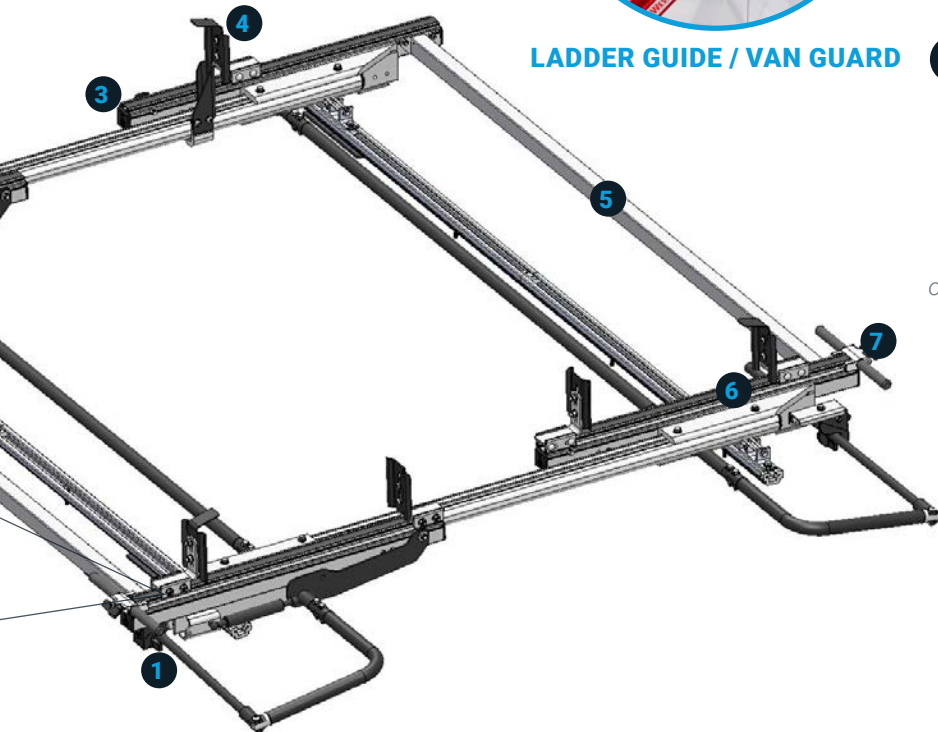

**EASY RELEASE T-HANDLE**  
*only available on the two stage option*

# GRIP-LOCK

Gain better peace-of-mind with the new PROFILE™ Grip-Lock Ladder Rack. Simple one handle operation and adjustable clamping pads provide safe and easy operation with flexibility to carry a wide variety of ladders.

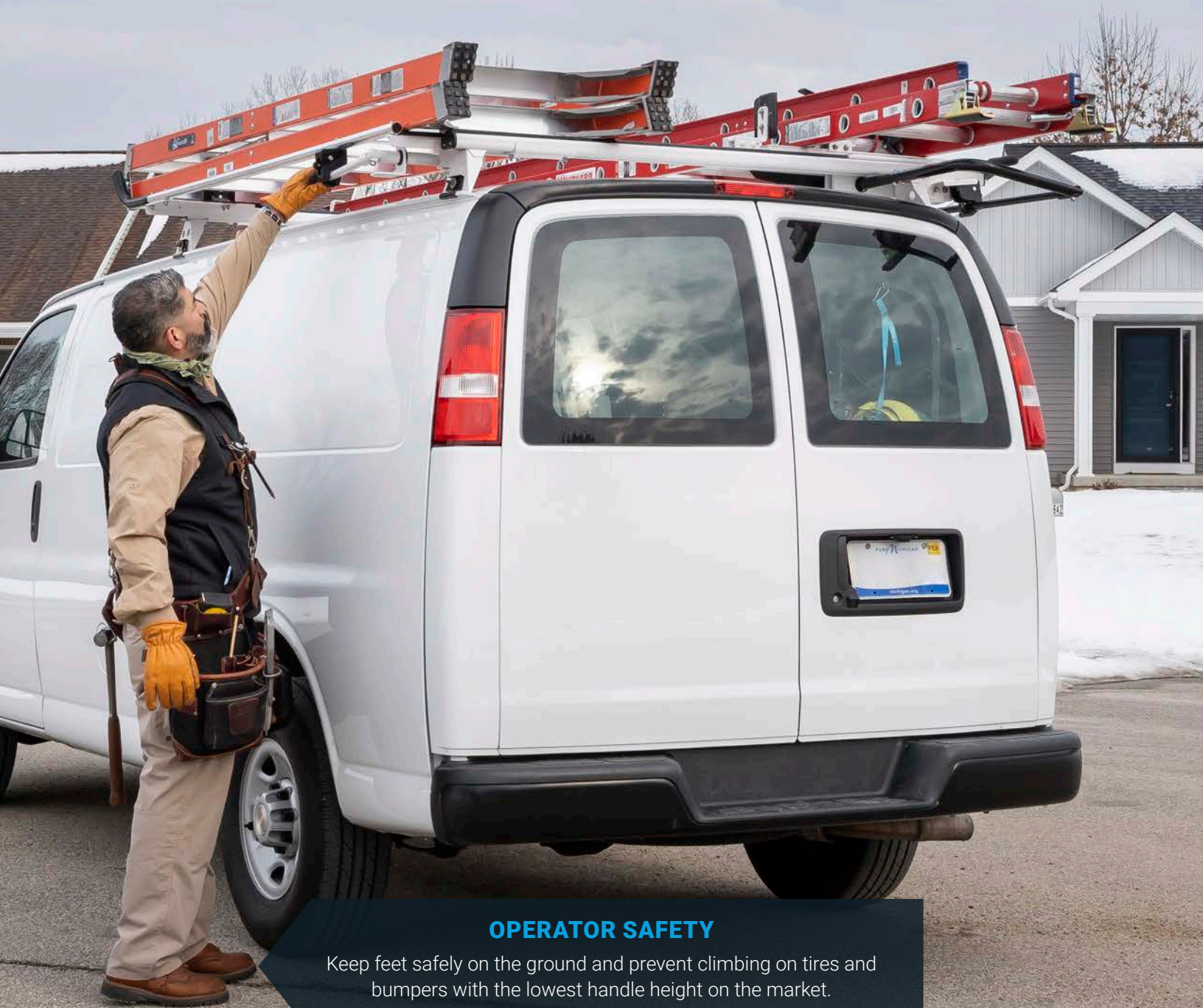

## OPERATOR SAFETY

Keep feet safely on the ground and prevent climbing on tires and bumpers with the lowest handle height on the market.

## CORROSION RESISTANT

100% aluminum with stainless steel fasteners, this rack resists rust giving you a clean professional look all year round.



1

## FLEXIBILITY

Designed with adjustable clamp brackets, this ladder rack will secure 6ft. step ladders all the way up to 40ft extension ladders.



2



3



## LADDER PROTECTION

Coated aluminum clamp pads reduce rattling and help extend ladder life.

4



## LADDER SECURITY

Lock capable handle to help prevent theft and keep your ladder secure.

# HD UTILITY

This rack is modular in design allowing you to build a custom rack to support the variety of cargo you need to carry on top of your van, pickup truck or KUV.

## What's Available?

- 2 and 3 bar configurations
- 3 different uprights to choose from
- Aluminum and PVC Conduit Kit Add-Ons
- Ladder Stop Add-On
- Rear Roller Add-On

## Product Insight

- Available for all full-size and compact vans
- No-Drill Installation
- 100% aluminum design with stainless steel fasteners
- Light weight & corrosion resistant
- Only pay for what you need on the rack



MADE IN USA

## 2 OR 3 BAR CONFIGURATIONS



## 4 UPRIGHT OPTIONS



4" Plastisol



6" Plastisol



9" Plastisol

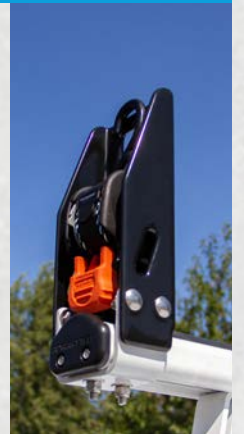

9" Plastisol  
w/ Ratchet

## ADD-ON ACCESSORIES



Ladder Stop



Rear Roller (Full-size vans only)



PVC Conduit Caps (4" & 6")



Aluminum Conduit Kits (10'6" & 12'6")

PROFILE™

HD UTILITY





**ADRIAN STEEL®**

*Cargo Management Solutions for Commercial Vehicles*



**ADRIAN STEEL®**

Cargo Management Solutions for Commercial Vehicles

**PROFILE™**



**PROLIFT™**



**GRIP-LOCK™**



**HD UTILITY**



MADE IN USA



**ADRIAN STEEL COMPANY**

info@adriansteel.com

800.677.2726